



User Manual

15" Panel Mount Monitor

Model Numbers: HIS-ML15- _ _ _ C



TABLE OF CONTENTS

Safety and Regulation Information	3
Factory Preset Timing.....	4
Panel Controls and OSD Functions.....	5
Brightness/Contrast Controls.....	6
On-Screen Display Functions	
Image Lock Function.....	7
Horizontal and Vertical Position Adjustment.....	8
Reset.....	9
Color Temperature and Control.....	10
OSD Language	11
Menu Position	12
Menu Display Time, Mode.....	13
Auto Adjustment	14
OSD Lock / Unlock.....	14
Installation Instructions	15
Cleaning	17
Troubleshooting.....	18
Drawings	21
Specifications	22
Warranty Statement.....	25

Safety and Regulatory Information

Warning

To prevent fire or shock hazard, do not expose the unit to rain or moisture. Dangerously high voltages are present inside the unit. Do not disassemble the unit. Refer servicing to qualified personnel only.

This equipment is not intended for use in critical applications where its failure to operate would create immediate life threatening circumstances. Applications including but no limited to nuclear reactor control, aerospace navigation systems and life support systems are not appropriate for this product.

This product is intended to be mounted in a suitable cabinet or other enclosure. The NEMA 4, 4x or 12 ratings are applicable only when properly installed in a like rated enclosure.

This product is a UL Recognized Component and must be used with a listed computer.

FCC Notice

This equipment has been tested and found to comply with the limits for a Class A digital device, pursuant to Part 15 of the FCC Rules. These limits are designed to provide reasonable protection against harmful interference when the equipment is operated in a commercial environment. This equipment generates, uses and can radiate radio frequency energy and, if not installed and used in accordance with the instruction manual, may cause harmful interference to radio communications. Operation of this equipment in a residential area is likely to cause harmful interference in which case the user will be required to correct the interference at his own expense. Any changes or modifications not expressly approved by the grantee of this device could void the user's authority to operate the device.

Factory Preset Timing

Resolution	Horizontal Frequency (KHz)	Vertical Frequency (Hz)	Pixel Clock (MHz)	Sync Polarity (H/V)
IBM, 640 x 350	31.469	70.086	25.175	-/-
IBM, 640 x 480	31.469	59.940	25.175	-/-
IBM, 720 x 400	31.469	70.087	28.322	-/+
VESA, 640 x 480	37.500	75.000	31.500	-/-
VESA, 640 x 480	37.861	72.809	31.500	-/-
VESA, 800 x 600	35.156	56.250	36.000	+,- /+,-
VESA, 800 x 600	37.879	60.317	40.000	+/+
VESA, 800 x 600	46.875	75.000	49.500	+/+
VESA, 800 x 600	48.077	72.188	50.000	+/+
*VESA, 1024 x 768	48.363	60.004	65.000	-/-
VESA, 1024 x 768	56.476	70.000	75.000	-/-
VESA, 1024 x 768	60.023	75.029	78.750	+/+

* Factory recommended timings for best picture quality

Panel Controls and OSD Functions

Control Panel Button	Control Function	Description
POWER	Power On/Off switch*	Soft power on/off button. Adjacent LED is lit when on.
MENU	Menu Button	Open the On-Screen Display (OSD) and active a highlighted menu item.
+ , -	Adjustment Buttons	Use these buttons to highlight and adjust items using the OSD. <i>These buttons are also direct access buttons for the brightness feature.</i>
EXIT	Exit	Use this button to Exit the active menu or the OSD.
AUTO	Automatic sync	Use this button for direct access to automatic adjustment of display.

Power Indicator

This light glows green during normal operation, and blinks green once as the monitor saves your adjustments.



* **Note:** This unit has “Energy Star” capability – you can leave device power in the on state when the computer is powered off.

Brightness and Contrast Controls



Brightness

Adjust the Brightness.

1. Push the Menu () button.
2. Push the Menu () button to open the Brightness adjustment screen.
3. Use the + button to increase the brightness or - button to decrease the brightness.

Direct Access Feature :

When OSD is not on the screen, Push the + or - button to adjust brightness.(SyncMaster 151S)

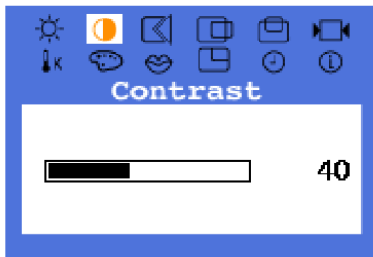

Contrast

Adjust the Contrast.





1. Push the Menu () button.
2. Push the - button or + button until the Contrast screen is displayed.
3. Push the Menu () button to open the Contrast adjustment screen.
4. Use the + button to increase the contrast or - button to decrease the contrast.

Image Lock





Fine

Image Lock is used to fine tune and get the best image by removing noises that creates unstable images with jitters and shimmers. If satisfactory results are not obtained using the Fine adjustment, use the Coarse adjustment and then use Fine again.

1. Push the Menu () button.
2. Push the - button or + button until the Image Lock screen is displayed.
3. Push the Menu () button twice to open the Fine adjustment screen.
4. Use the - or + buttons to remove any noise.

Coarse

Image Lock is used to fine tune and get the best image by removing noises that creates unstable images with jitters and shimmers. If satisfactory results are not obtained using the Fine adjustment, use the Coarse adjustment and then use Fine again.

1. Push the Menu () button.
2. Push the - button or + button until the Image Lock screen is displayed.
3. Push the Menu () button again and then press the - or + button until the Coarse screen appears. Push the Menu () button to open the Coarse adjustment screen.
4. Use the - or + buttons to remove any noise.

Note : Limit Reached!

Push the - button, then 'Limit Reached!' will be appeared on the bottom side of the OSD.

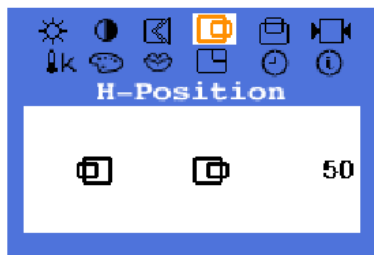

In this case, no longer acceptable to decrease Coarse.

Horizontal and Vertical Position Adjustment



H-Position

Follow these instructions to change the horizontal position of the monitor's entire display.

1. Push the Menu () button.
2. Push the - button or + button until the H-Position screen is displayed.
3. Push the Menu () button to open the H-Position adjustment screen.
4. Use the - and + buttons to change the horizontal position of the monitor's viewing area.

Note : Limit Reached!

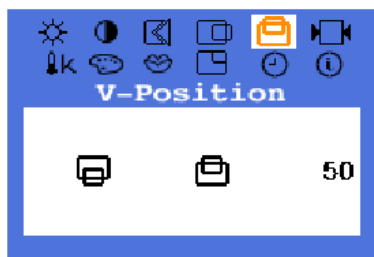

Push the - button, then 'Limit Reached!' will be appeared on the bottom side of the OSD.

In this case, no longer acceptable to decrease H-Position.



V-Position

Follow these instructions to change the vertical position of the monitor's entire display.

1. Push the Menu () button.
2. Push the - button or + button until the V-Position screen is displayed.
3. Push the Menu () button to open the V-Position adjustment screen.
4. Use the - and + buttons to change the vertical position of the monitor's viewing area.

Note : Limit Reached!

Push the - button, then 'Limit Reached!' will be appeared on the bottom side of the OSD.

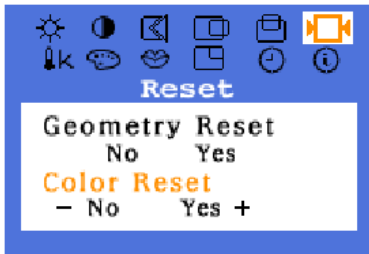
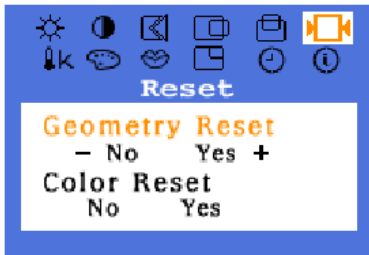
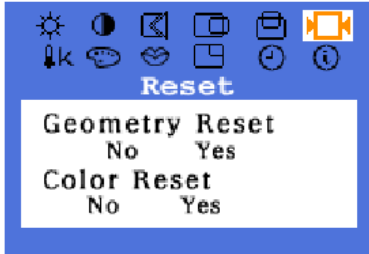

In this case, no longer acceptable to decrease V-Position.

Reset Functions





Geometry Reset

Geometry parameters are replaced with the factory default values.

1. Push the Menu () button.
2. Push the - button or + button until the Reset screen is displayed.
3. Push the Menu () button twice to open the Geometry Reset adjustment screen.
4. Push the + button to select Yes.
If you don't want to reset the monitor, use the - button to select No.

Color Reset

Color parameters are replaced with the factory default values.

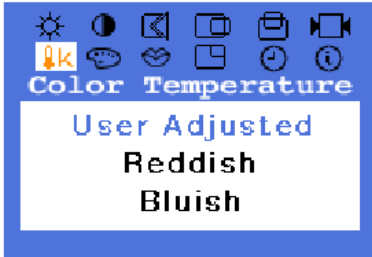

1. Push the Menu () button.
2. Push the - button or + button until the Reset screen is displayed.
3. Push the Menu () button again and then press the - or + button until the Color Reset screen appears. Push the Menu () button to open the Color Reset adjustment screen.
4. Push the + button to select Yes.
If you don't want to reset the monitor, use the - button to select No.

Color Temperature and Color Control



Color Temperature



Color temperature is a measure of the "warmth" of the image colors.

1. Push the Menu () button.
2. Push the - button or + button until the Color Temperature screen is displayed.
3. Push the Menu () button to open the Color Temperature adjustment screen.
4. Press the - or + button to select User Adjusted, Reddish or Bluish.



Color Control

Follow these steps to adjust individual R,G,B color control.

1. Push the Menu () button.
2. Push the - button or + button until the Color Control screen is displayed.
3. Push the Menu () button to open the Color Control adjustment screen. Use the - or + button to select R(ed), G(reen) or B(lue) and Push the Menu () button.
4. Press the - or + button to adjust the color setting.

OSD Language





Language

Follow these steps to change the language used in the menu.

You can choose one of six languages.

English, German, Spanish, French, Italian, Swedish.

Note : The language chosen affects only the language of the OSD. It has no effect on any software running on the computer.

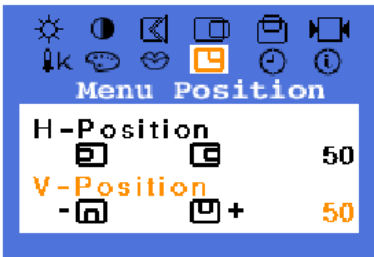
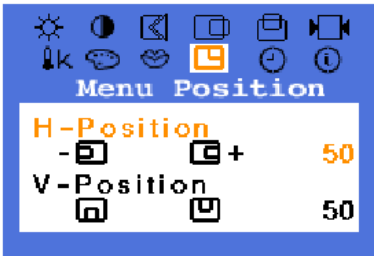
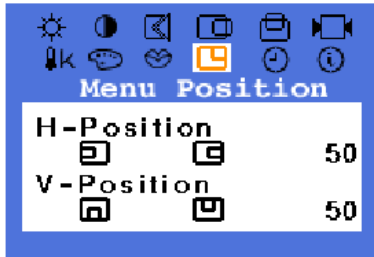

1. Push the Menu () button.
2. Push the - button or + button until the Languages screen is displayed.
3. Push the Menu () button to open the languages selection screen.
4. Use the - button or + button to select the language you would like to use.

Menu Position





H-Position

You can change the horizontal position where the OSD menu appears on your monitor.

1. Push the Menu () button.
2. Push the - button or + button until the H-Menu Position screen is displayed.
3. Push the Menu () button twice to open the H-Position adjustment screen.
4. Use the - and + buttons to place the menu in the horizontal position you prefer.

V-Position

You can change the vertical position where the OSD menu appears on your monitor.

1. Push the Menu () button.
2. Push the - button or + button until the V-Menu Position screen is displayed
3. Push the Menu () button again and then press the - or + button until the V-Position screen appears. Push the Menu () button to open the V-Position adjustment screen.
4. Use the - and + buttons to place the menu in the vertical position you prefer.

Auto Adjustment, OSD Lock/Unlock

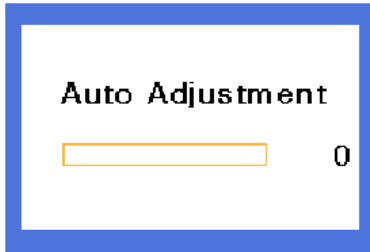

● Auto Adjustment



Auto adjustment allows the monitor to self-adjust to the incoming video signal. The values of fine, coarse and position are adjusted automatically.

1. Push the Auto button.

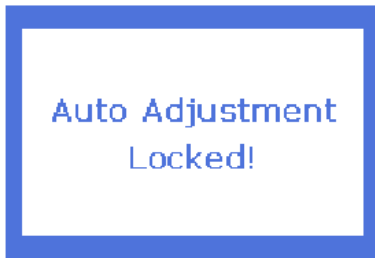
To make the automatic adjustment function sharper, execute the 'AUTO' function while the **AUTO PATTERN** is on.



● OSD Lock/Unlock

1. Push and hold in the Menu () button for 5 seconds or more to Lock the OSD.
2. Push and hold in the Menu () button for 5 seconds or more to Unlock the OSD.

Installation Instructions

Preparing for Installation

Important! Perform the following steps BEFORE Installation of the monitor into the panel.

1. Ensure that sufficient power is available.
2. Ensure that sufficient space is available to allow for proper air flow into and out of the unit.
3. Ensure that the air temperature around the unit (top and bottom) will not exceed the rated specifications of the unit.

→ *The maximum rated temperature of the HIS-ML15 is 50 °C (132 °F)*

→ *Remember that heat rises – the temperature at the top of the cabinet will be much hotter than at the bottom when the air is not circulating.*

→ *Also, remember that even though this product is designed to operate at 50 °C, the life span of any electronic device is shortened when it is consistently operated at high temperatures. Therefore it is wise to take steps to keep the temperature of the ambient air around the unit as low as possible.*

4. Ensure that the ambient humidity of the air around the unit does not exceed the rated specifications for the unit

→ *The maximum rated humidity for the HIS-ML15 is 90% non-condensing*

Installation into Panel

1. Refer to the drawing below.
2. Locate position in panel for mounting of the monitor. Assure that there is adequate space begin the panel. Allow extra space (0.5 in. behind and on each side) for air ventilation.
3. Cut a rectangular hole in the panel. Clean and deburr.
Dimensions: 16.02" (406mm) W x 12.72" (323mm) H ; +/- .020"
4. Separate the rear collar from the unit by removing the 12 nuts.
5. Insert the unit into the front of the panel and re-attach the collar.
6. Tighten all 12 nuts to a torque of 24 inch-pounds to assure a water-tight seal between the poron bezel gasket on the monitor and equipment panel.
HIS will not assume liability for damage to internal electronics due to improper installation.

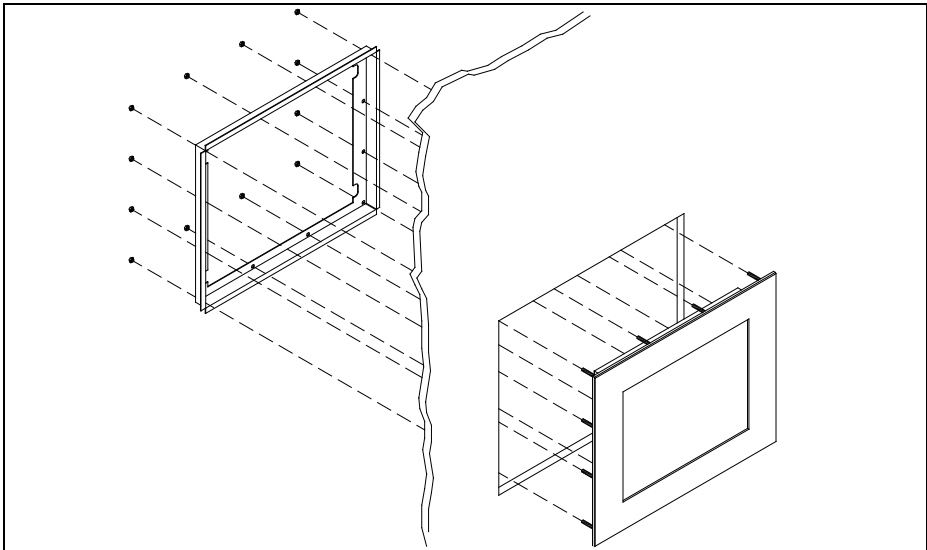

Cleaning

Resistive Touchscreen model

Any standard glass cleaner can be used to clean the touchscreen. Always spray the glass cleaner on the cloth or towel and then clean the touchscreen. Glass cleaner sprayed directly on the monitor could possibly leak inside a non-sealed unit and cause damage.

Vinegar or ammonia will not hurt the touchscreen. Again, spray the cloth and then clean the touchscreen.

Tempered Anti-Reflective Glass Window

Use any standard glass cleaner as long as there is no abrasive or oily content. The anti-reflective coatings are physically part of the surface of the glass and resist degradation to the Military Specifications.

Acrylic Bezel

The acrylic front bezel can be cleaned in the same manner as the touchscreen or glass window.

Troubleshooting

Blank Screen

After installing the power adapter and connecting I/O cable to a PC, the monitor displays a blank screen.

- Press the power button and check to see if the power LED is lit.
- If the LED turns green, make sure the PC is powered on. Make sure all cables are connected.
- If the LED turns orange, check to see if the PC is in the power saving mode by pressing any keys on the keyboard.

Rolling Screen

- Change PC display resolution to 1024x768 at 60hz.
- Unplug the power adapter to monitor, then plug it in again.
- Press monitor power button again.
- Reset the monitor to the original factory setting.
- Press “Auto” button.

Unstable Screen

- Press the “Auto” button.
- Make sure the PC display resolution is not set greater than 1024x768 at 75hz.
- Make sure the PC display resolution matches one of the factory pre-set timings in this manual.
- Change the PC display resolution to 1024x768 at 60hz.
- Reset the monitor to the factory setting.
- Press the “Auto” button.

Screen is not perfect

- Make sure the PC display resolution matches one the factory preset timings shown in this manual.
- Recall factory setting. Refer to panel controls and OSD functions in this manual.
- Fine tune the picture by performing the following adjustments in this order – pitch, phase, and position. Refer to OSD functions in this manual.

Self-Test Feature Check

Self-Test Feature Check

Your monitor provides a self test feature that allows you to check whether your monitor is functioning properly.

Self-Test Feature Check

1. Turn off both your computer and the monitor.
2. Unplug the video cable from the back of the computer.
3. Turn on the monitor.

If the monitor is functioning properly, you will see a box with a border and text inside as shown in the following illustration:

The three boxes inside the border are red, green and blue.

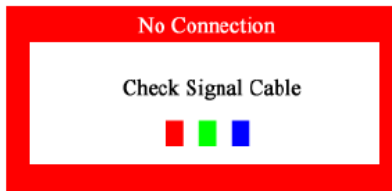

Failure of any of the boxes to appear indicates a problem with your monitor.

This box also appears during normal operation if the video cable becomes disconnected or damaged.

4. Turn off your monitor and reconnect the video cable; then turn on both your computer and the monitor.

If your monitor screen remains blank after using the previous procedure, check your video controller and computer system; your monitor is functioning properly.

Self-Test Feature Check

Warning Messages

If there is something wrong with the input signal, a message appears on the screen or the screen goes blank although the power indicator LED is still on. The message may indicate that the monitor is out of scan range or that you need to check the signal cable.



Environment

The location and the position of the monitor may influence the quality and other features of the monitor.

1. If there are any woofer speakers near the monitor, unplug and relocate the woofer to another room.
2. Remove all electronic devices such as radios, fans, clocks and telephones that are within 3 feet (one meter) of the monitor.

Useful Tips

- A monitor recreates visual signals received from the PC. Therefore, if there is trouble with the PC or the video card, this can cause the monitor to become blank, have poor coloring, noise, Video mode not supported, etc. In this case, first check the source of the problem, and then contact a service center or your dealer.
- **Judging the monitor's working condition**
If there is no image on the screen or an "Video mode not supported" message comes up, disconnect the cable from the computer while the monitor is still powered on.
 - If there is a message coming up on the screen or if the screen goes white, this means the monitor is in working condition.
 - In this case, check the computer for trouble.

Drawings

Front and Side Views

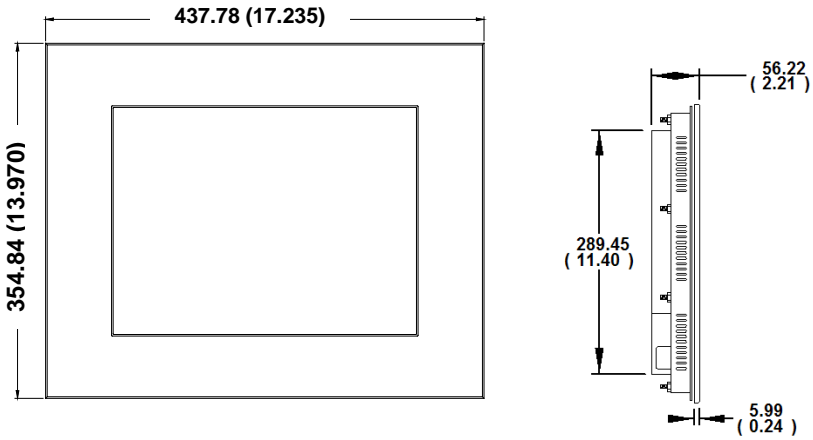

Rear View (Showing Cutout Dimensions)

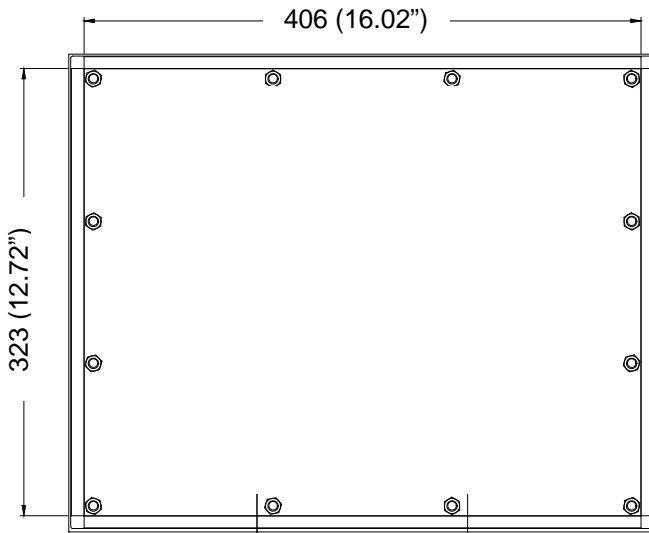

Rear and Bottom Views

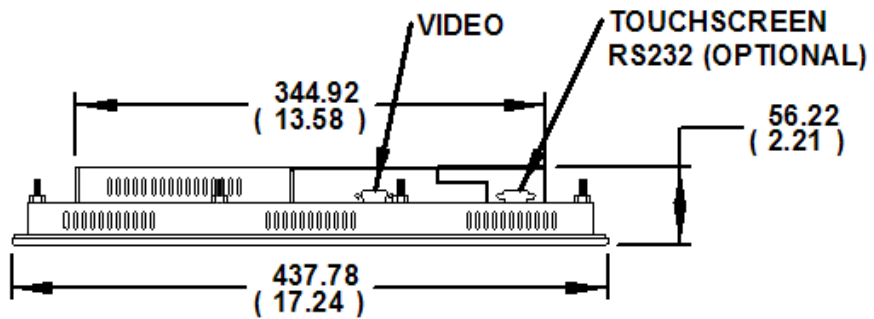
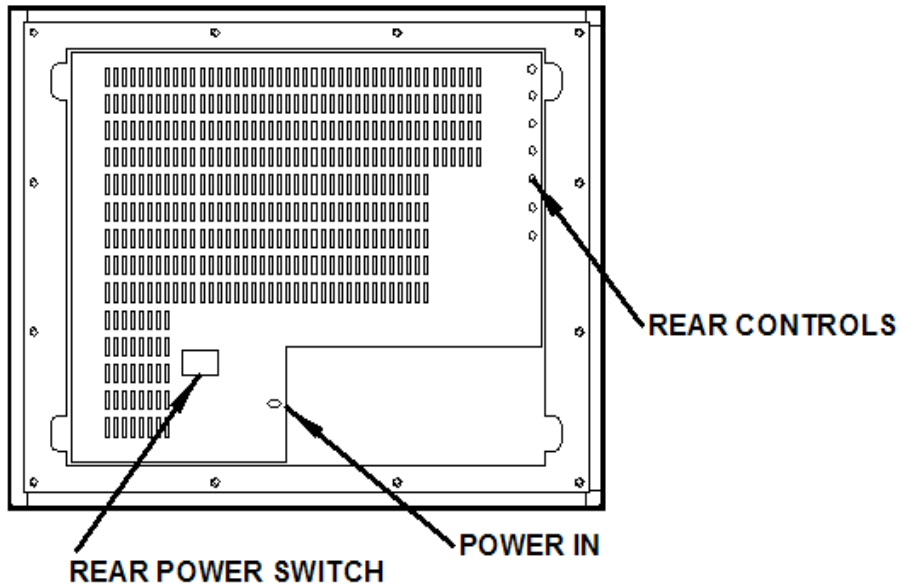

Specifications

Display

Type	Thin-film transistor (TFT) Active Matrix Liquid Crystal
Size	15.0" diagonal
Image size	12.0" (304mm) x 9.0" (228mm)
Native resolution	XGA (1024 x 768)
Plug and Play	DDC1/2B compatible`
Minimum resolution	VGA (640 x 480)
Pixel pitch	0.297mm x 0.297mm
Number of colors	16 million
Viewing Angle (Hori/Vert)	140° / 115°, typical
Brightness (white)	250 nits (cd/m ²) max
Contrast ratio	330:1 (typical)
Back light	Two CCFTs (Cold Cathode Fluorescent Tube); 35,000 hours brightness half-life; replaceable
Screen protector (when not shipped with touch-screen)	Tempered glass to ANSI-Z97.1 SPEC; AR coated on both sides; 98% Transmission of light; 99% Reduction of glare; 53% UV blocking; 30% NIR Blocking; proprietary hydrophobic coating on outside reduces fingerprint smears, repels liquid spills and makes glass easy to clean.

Video

Input connector	HD-15 (optional BNC input)
Input signal format	RGB Analog video 0 – 0.7V p-p – sep V and H, combined sync, sync on green
Horizontal scan	30kHz – 60kHz
Supported Video Standards	Std VGA – 640x480 @ 60Hz SVGA – 800x600 @ 60Hz XGA – 1024x768 @ 60Hz (native)
Vertical scan	56Hz – 75 Hz
Response rate (typical)	10ms rising, 35ms falling

Electrical

Monitor input	90VAC – 264VAC, 50/60Hz (+/- 3Hz)
Power consumption	Approximately 30 watts
Power management	DPMS/energy star, < 3W
Compliance	UL 1950, cUL 959; FCC Class A

Environmental

Temperature	0-50°C (consult factory for installation instructions when continuous 24/7 operation exceeds 40°C)
Humidity	20% to 90% non-condensing
Shock	30g (1/2 sine, 11 msec.)
Vibration	0.006 inch p-p 15-57Hz, 1.0g 57-640Hz sine
Altitude	Operating: up to 10,000 feet; Non-operating: up to 40,000 feet

Functional

Panel controls (rear access)	Power On/Off switch, Menu button, +, - Adjust buttons, Exit button, Auto-sync button
OSD (On Screen Display) controls	Brightness, contrast, image lock, H-position, V-position, Geometry reset, Color reset, Color Temperature, Color control, language, Menu position, menu display time, display mode, auto adjustment, OSD Lock/Unlock
Touch screen option	5-wire resistive system; emulates a mouse; RS-232 interface to host computer

Enclosure

Type	Panel mount; rear collar compresses gasket against panel, held by 12 10-32 studs
Panel rating	NEMA 12/4/4X (with proper installation) – built to IP65 standards

Physical

Depth	2.1" behind panel maximum
Bezel	Acrylic – matte finish, black; or Stainless Steel
Front bezel outside dimensions	17.2" (437mm) W x 13.97" (355mm) H x 0.236" thick (not including gasket)
Cutout dimensions	16.02" (406mm) W x 12.72" (323mm) H ; +/- .020"
Net weight	13 lbs.
Shipping weight	17 lbs.

VGA Pin assignment

Pin No.	Signal	Pin No.	Signal
1	Red	9	No pin
2	Green	10	Ground
3	Blue	11	Ground
4	Ground	12	SDA
5	Ground	13	H. sync
6	Ground	14	V. sync
7	Ground	15	SCL
8	Ground		

Warranty Statement

Who is Covered?

This warranty covers the purchaser of this product only and is not transferable without our written consent.

What Does This Warranty Cover and What is the Period of Coverage?

We warrant this product to be free from defects in material and workmanship, subject to the conditions set forth below. This warranty remains in force for a three-year period beginning on the date we invoice you for the product. If HIS repairs or replaces a product under warranty, its warranty term is not extended.

What Will We Do to Correct Problems and How Do You Get Service?

We will repair or replace (at our sole option) any part of the unit which proves to be defective. Replacement parts may be new or refurbished and will meet the same specifications of the original parts or unit. We will return the product to you by the shipping method we choose in the U.S.A. at our expense. You must pay for shipments to locations outside of the U.S.A. In order to receive warranty service you must get prior approval from HIS. To request warranty service you can telephone us at 770-992-0297 or send an email to service@HISmonitors.com. If we determine that warranty service is needed we will give you a Return Material Authorization (RMA) number. This RMA number must be conspicuously marked on the outside of the shipping box. HIS will not accept shipments not accompanied by the RMA number. You must ship or deliver the product to HIS Freight prepaid.

What Does This Warranty Not Cover?

This warranty does not cover equipment which has been damaged due to misuse, abuse or accident such as: operating the equipment outside of published specifications; displaying fixed images for long periods of time resulting in afterimage effects; improper or unauthorized repair by anyone other than HIS or a service agency authorized by HIS to perform such repairs; fire, flood, "acts of God", or other contingencies beyond the control of HIS.

HIS' responsibility for malfunctions and defects in hardware is limited to repair and replacement as set forth in this warranty statement. HIS shall not be liable for direct, indirect, incidental, consequential, or other types of damages resulting from the use of any HIS product other than the liability stated above. These warranties are in lieu of all other warranties express or implied, including, but not limited to, the implied warranties of merchantability or fitness for a particular purpose. Some states do not allow the exclusion of implied warranties or the limitation or exclusion of liability for incidental or consequential damages so the above exclusions or limitations may not apply to you. You are cautioned that the performance of this product can be affected by many factors, such as system configuration, software, application, and operator control of the system. It is your responsibility to determine suitability of this product for your purpose and application.

