

Top View

Side View

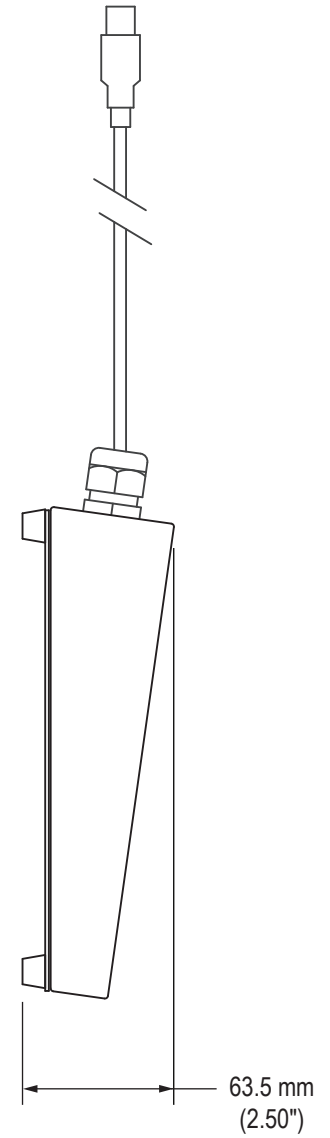

# Detailed Top View Showing Keys (KB-M2-EXT series)

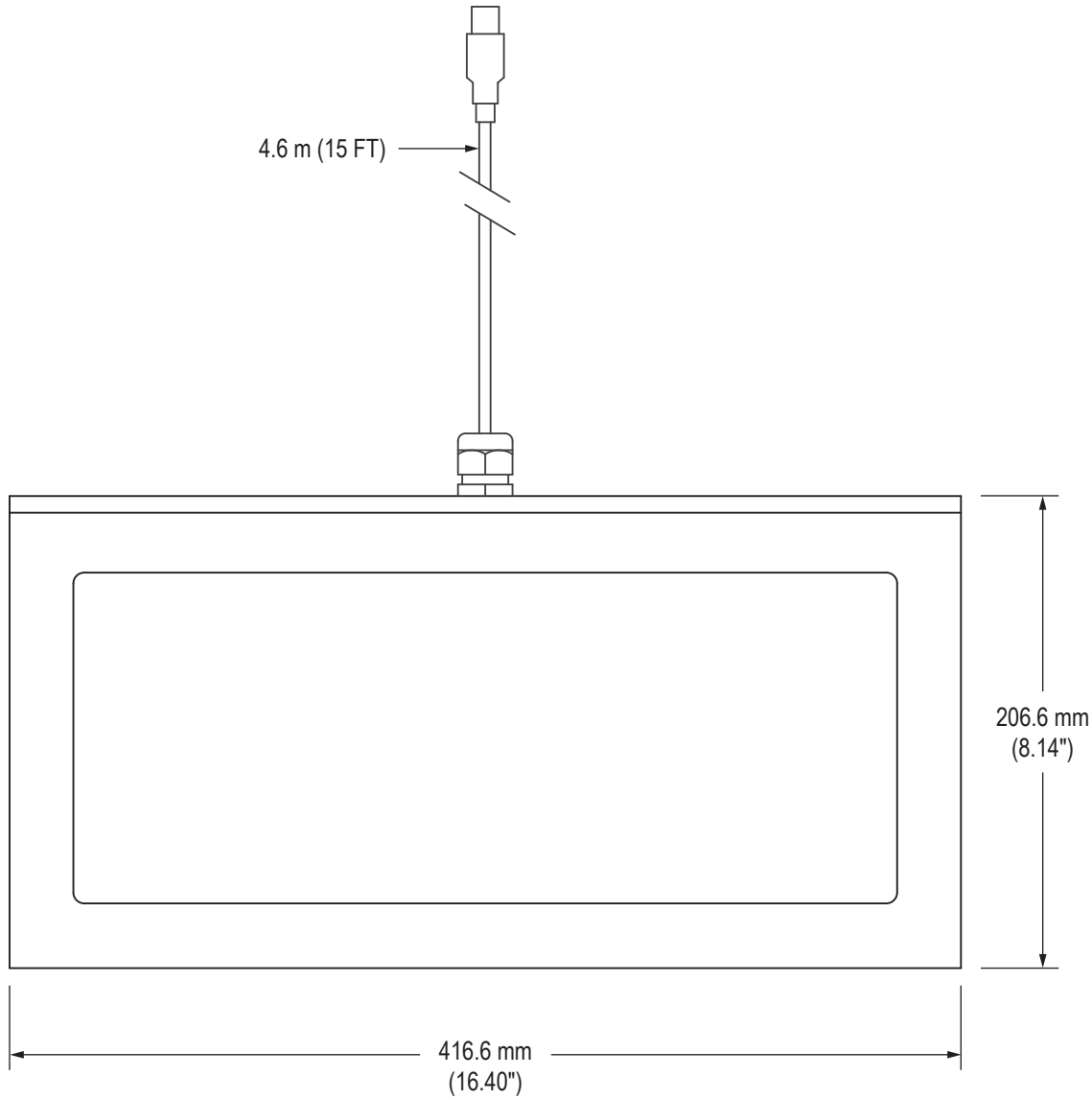
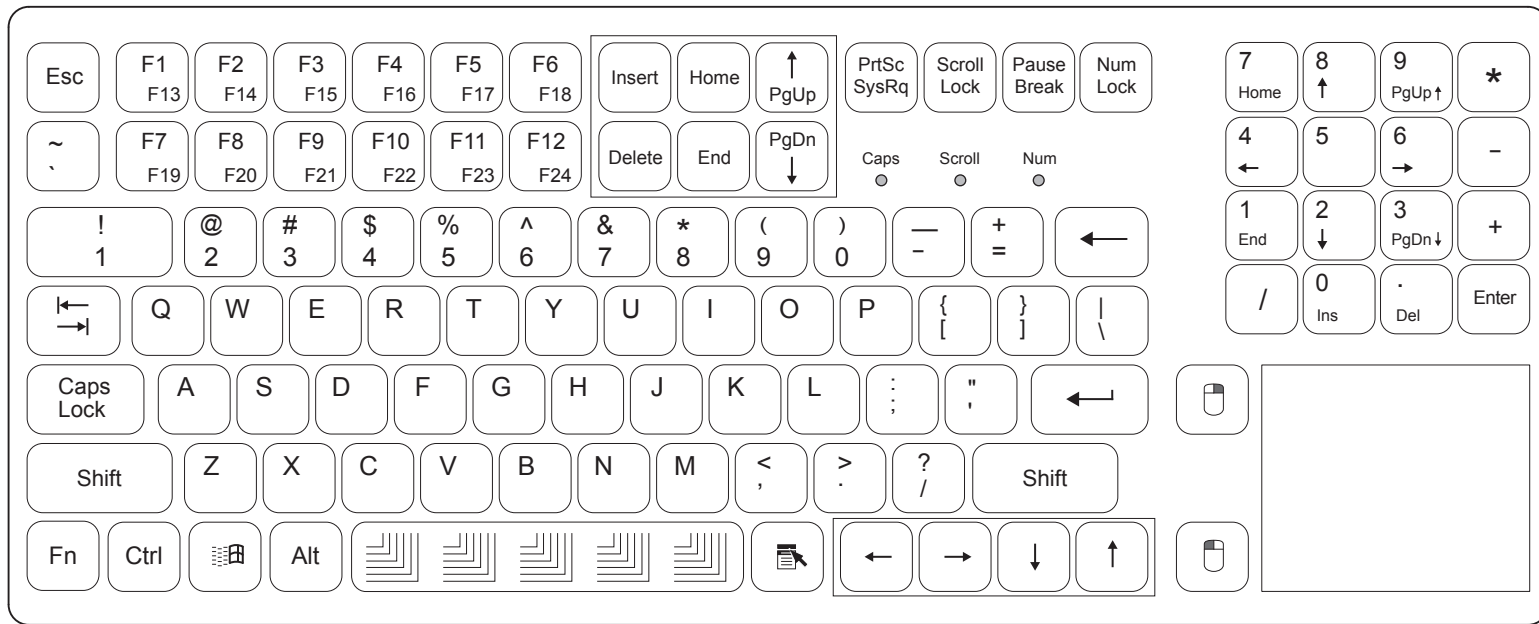

Mechanical Drawing – Benchtop Keyboard

416.6 mm  
(16.40")

206.6 mm  
(8.14")

© 2019



**Hope Industrial Systems, Inc.**  
 Toll Free: (877) 762-9790 · International: +1 (678) 762-9790  
 UK: +44 (0) 20 7193 2618 · E-mail: support@HopeIndustrial.com

Part Number: KB-BCH series

Revision:

Date: 2018.08.01

Page 2 of 4

NOTES:

# Detailed Top View Showing Keys (KB-R2-EXT series)



416.6 mm  
(16.40")

206.6 mm  
(8.14")

Mechanical Drawing – Benchtop Keyboard

© 2019



Hope Industrial Systems, Inc.  
Toll Free: (877) 762-9790 · International: +1 (678) 762-9790  
UK: +44 (0) 20 7193 2618 · E-mail: support@HopeIndustrial.com

Part Number: KB-BCH series  
Revision:

Date: 2018.08.01  
Page 3 of 4

NOTES:

# Detailed Top View Showing Keys (KB-R3-EXT series)

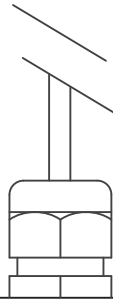

206.6 mm  
(8.14")

416.6 mm  
(16.40")

Mechanical Drawing – Benchtop Keyboard

© 2019



Hope Industrial Systems, Inc.  
 Toll Free: (877) 762-9790 · International: +1 (678) 762-9790  
 UK: +44 (0) 20 7193 2618 · E-mail: support@HopeIndustrial.com

Part Number: KB-BCH series  
 Revision:

Date: 2018.08.01  
 Page 4 of 4

NOTES: