

15/17" MODEL

Top View (Collapsed)

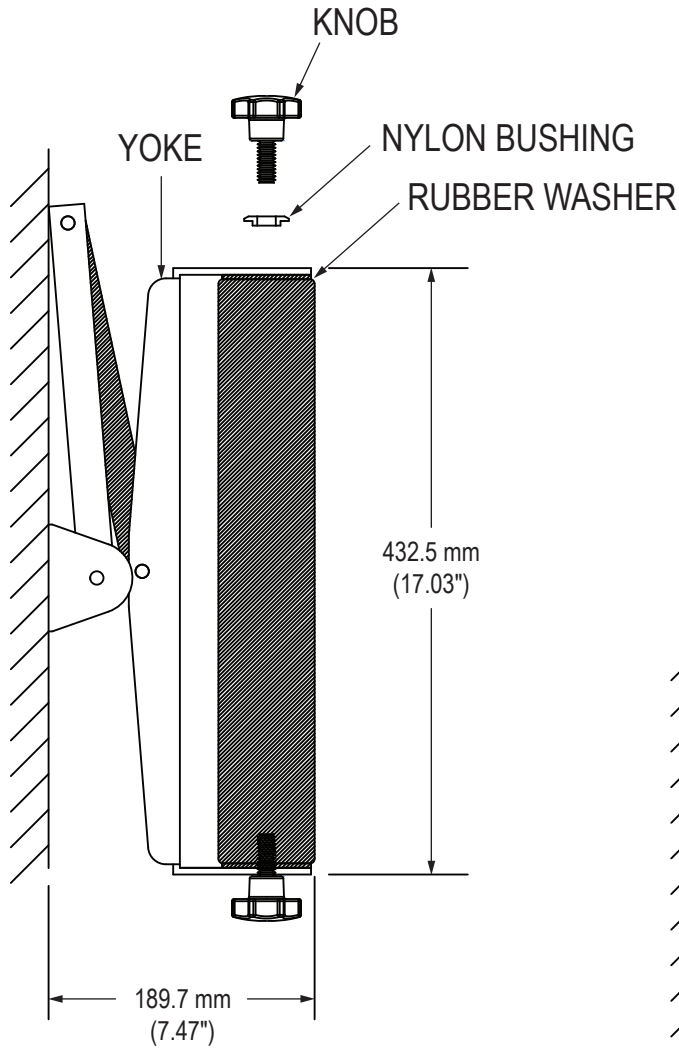

Mounting Bracket

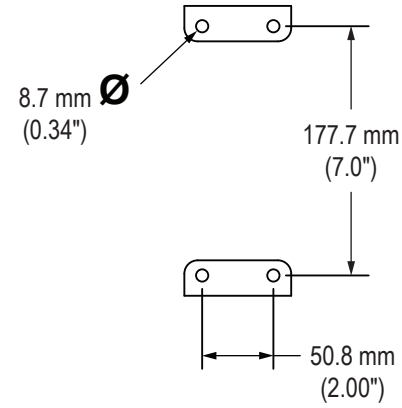

Side View (Extended)

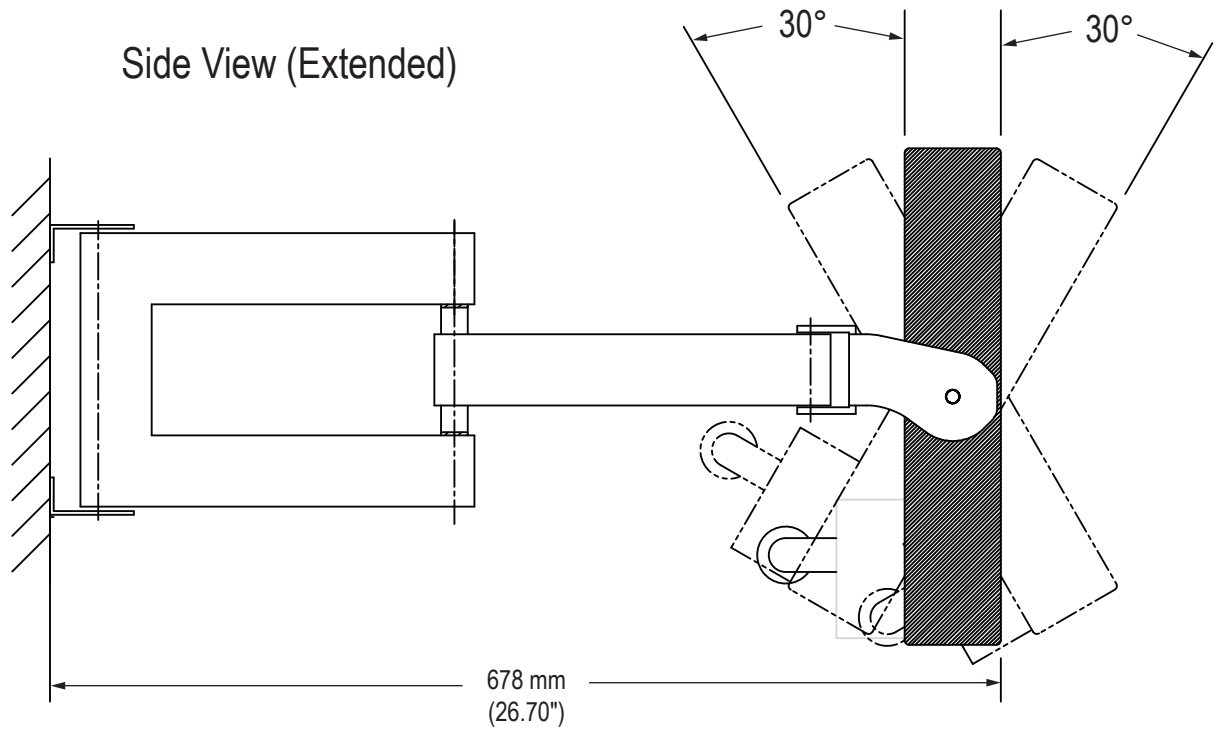

19" MODEL

Top View (Collapsed)

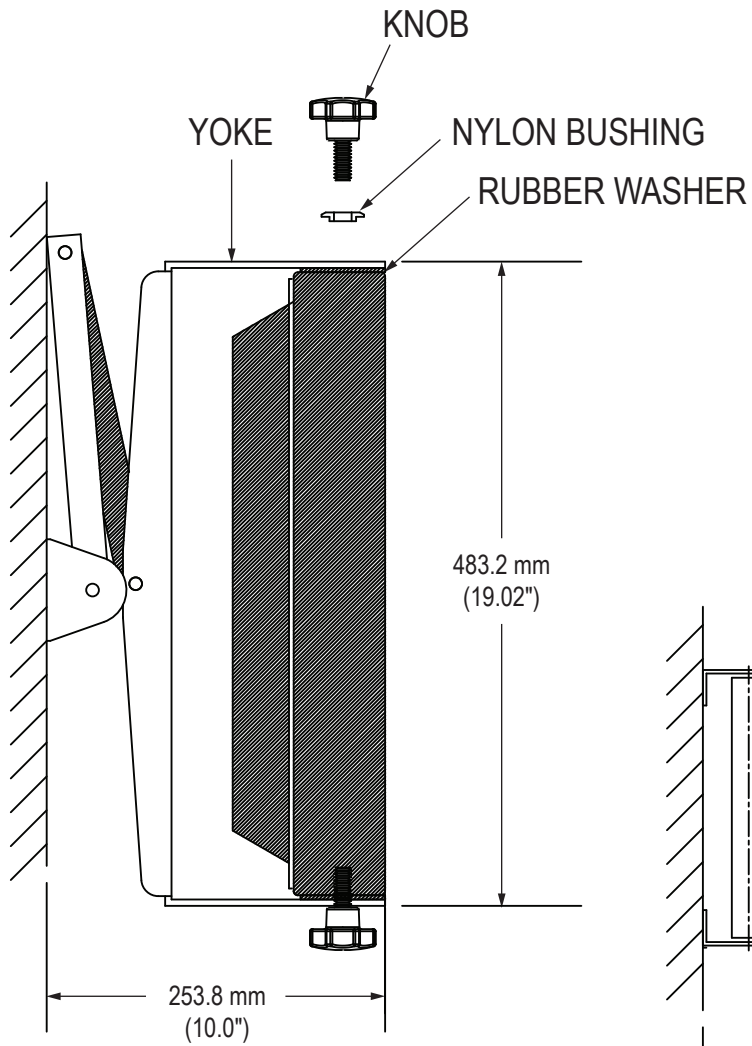

Mounting Bracket

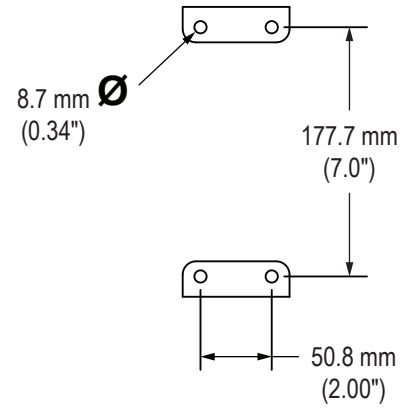

Side View (Extended)

